



Specifying Fans for Industrial Environments

AMCA Speakers Network Presentation | AMCA International | www.amca.org

AMCA International has met the standards and requirements of the Registered Continuing Education Program. Credit earned on completion of this program will be reported to RCEP at RCEP.net. A certificate of completion will be issued to each participant. As such, it does not include content that may be deemed or construed to be an approval or endorsement by the RCEP.

Attendance for the entire webinar AND a completed evaluation is required for PDH credit to be issued. Partial credit cannot be given if you leave the webinar early.



DISCLAIMER

The information contained in this webinar is provided by AMCA International as an educational service and is not intended to serve as professional engineering and/or manufacturing advice. The views and/or opinions expressed in this educational activity are those of the speaker(s) and do not necessarily represent the views of AMCA International. In making this educational activity available to its members and others, AMCA International is not endorsing, sponsoring or recommending a particular company, product or application. Under no circumstances, including negligence, shall AMCA International be liable for any damages arising out of a party's reliance upon or use of the content contained in this webinar.

COPYRIGHT MATERIALS

This educational activity is protected by U.S. and International copyright laws. Reproduction, distribution, display and use of the educational activity without written permission of the presenter is prohibited.

© AMCA International 2020

Specifying Fans for Industrial Environments

Purpose and Learning Objectives

The purpose of this presentation is to provide information on key environmental, aerodynamic, and mechanical aspects of industrial fan performance.

At the end of this presentation attendees will be able to:

1. Describe how industrial fans differ from commercial fans.
2. Define the different forms of pressure and flow.
3. Calculate density.
4. Compare centrifugal and axial impeller designs and how they impact fan pressure and efficiency.
5. Explain key considerations for selecting fans for abrasive, corrosive, and high-temperature environments.

TODAY'S WEBINAR PRESENTERS

Aaron Saldanha



Marcel Kamutzki



Dan Hormann

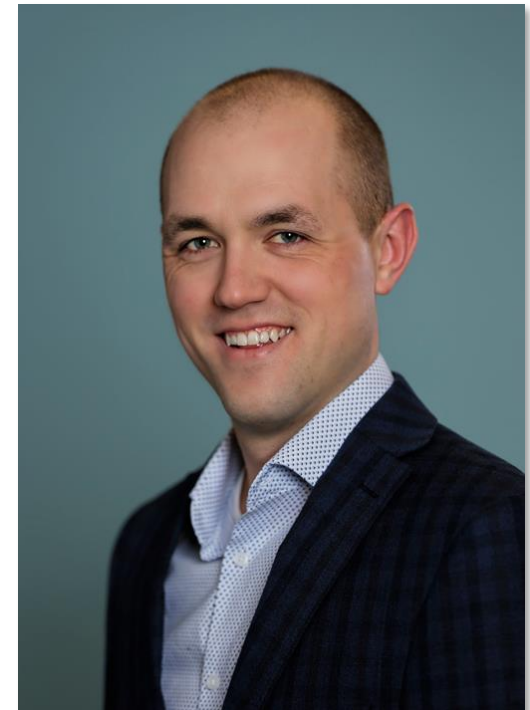

Aaron Saldanha

Sales Director- Industrial Fans,
AMCA Member Company

- Worked for over 13 years for leading fan companies in India and the U.S.
- Experience in engineering management, sales, production, quality and new product development
- Member of multiple AMCA and ASHRAE committees



Marcel Kamutzki

V.P. Engineering & Automation,
AMCA Member Company

- 30 years in custom fan manufacturing industry; currently the VP of Engineering and Design Automation
- Professional engineer registered in the province of Ontario, Canada
- Experience has included in-house software development, design engineering, and sales applications engineering for a large, multi-national fan manufacturer.



Dan Hormann

Engineering Manger,
AMCA Member Company

- Since 2012 he has designed custom heavy-duty fans for Utilities, Mining, Pulp & Paper, Tunnel Emergency Ventilation, and Oil & Gas Industries.
- Served 8 years in the U.S. Army Reserve
- B.S. in Mechanical Engineering from North Dakota State University



Commercial vs. Industrial Fans

- *Generally Heavier construction*
- *Increased stiffness and resonance separation*
- *Corrosion allowance*
- *Continuous welding*



Commercial vs. Industrial Fans

- *Bearing types*
- *Ball Bearings*
- *Spherical Roller Bearings*
- *Hydrodynamic Bearings*

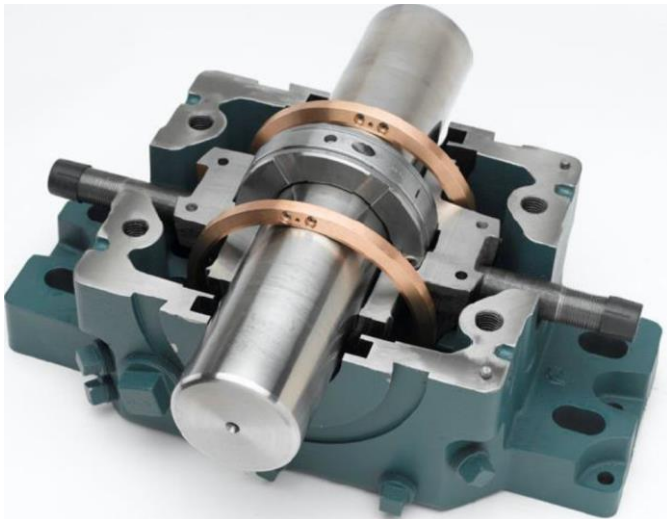

Spherical rollers take thrust and radial loads.

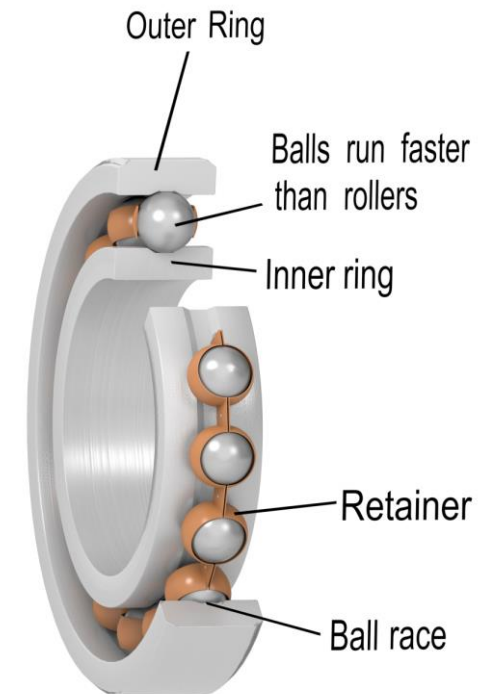
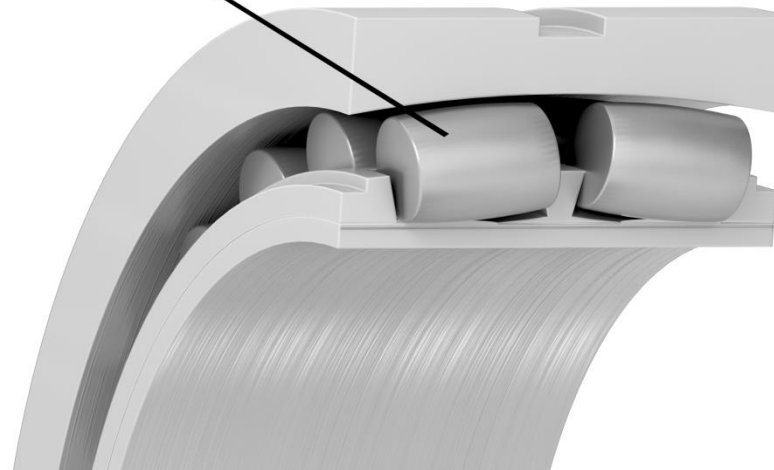

Commercial vs. Industrial Fans

- *Lower Allowable Vibration and Precision Balance Criteria*
- *AMCA 204*

APPLICATION	EXAMPLES	DRIVER POWER kW (HP) LIMITS	FAN APPLICATION CATEGORY, BV
RESIDENTIAL	Ceiling fans, attic fans, window AC	≤ .15(0.2) > .15(0.2)	BV-1 BV-2
HVAC & AGRICULTURAL	Building ventilation and air conditioning; commercial systems	≤ 3.7(5.0) > 3.7(5.0)	BV-2 BV-3
INDUSTRIAL PROCESS & POWER GENERATION, ETC.	Baghouse, scrubber, mine, conveying, boilers, combustion air, pollution control, wind tunnels	≤ 298(400) > 298(400)	BV-3 BV-4
TRANSPORTATION & MARINE	Locomotives, trucks, automobiles	≤ 15(20) > 15(20)	BV-3 BV-4
TRANSIT/TUNNEL	Subway emergency ventilation, tunnel fans, garage ventilation	≤ 75(100) > 75(100)	BV-3 BV-4
	Tunnel Jet Fans	ALL	BV-4
PETROCHEMICAL PROCESS	Hazardous gases, process fans	≤ 37(50) > 37(50)	BV-3 BV-4
COMPUTER CHIP MANUFACTURE	Clean room	ALL	BV-5

Commercial vs. Industrial Fans

- *Direct Drive vs. Belt Drive*
- *Belt Drives*
Disadvantages:
 - *Belt Wear*
 - *Belt Pass Frequency*
Vibration
 - *Decreased Bearing Life*
 - *Increased Maintenance*

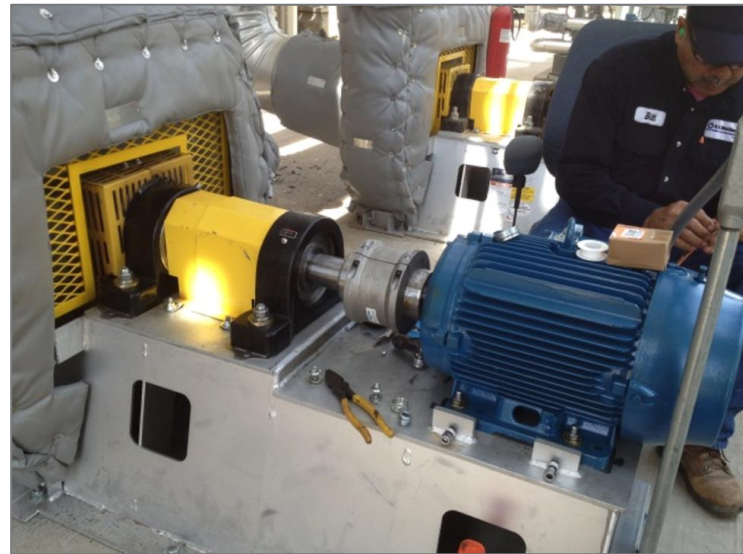

Commercial vs. Industrial Fans

- *Machinery Condition Monitoring*
- *Motor and Bearing Temperature*
- *Bearing Vibration*
- *Material Buildup and Imbalance Detection*
- *Preventative Maintenance*



Commercial vs. Industrial Fans

- Arrangement 8
- Direct Drive
- Impeller mounted fan shaft rather than motor shaft

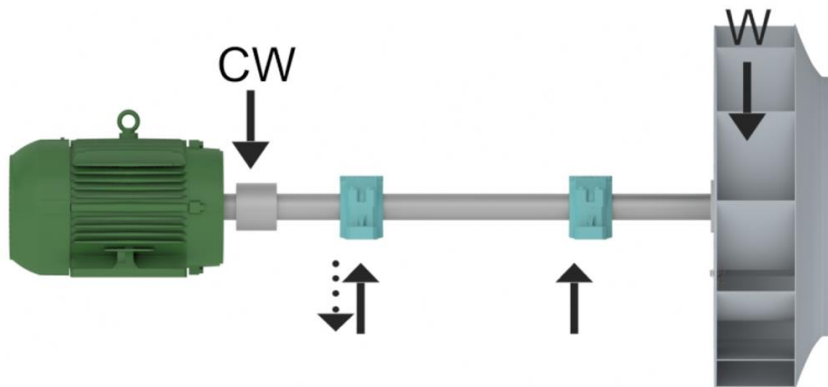

Commercial vs. Industrial Fans

- Arrangement 7
- Center Hung Rotor
- Larger Fan Shafts Permitted
- Bearings Mounted on Independent Pedestals

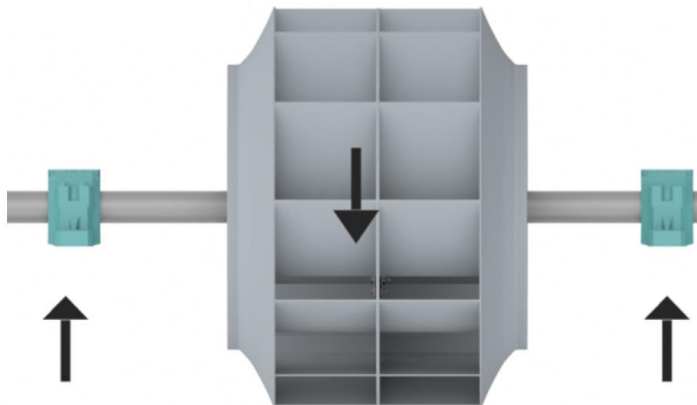

Commercial vs. Industrial Fans

- Inertia Bases
- Arrangement 7 or 8
- Spring Isolators and Concrete Fill
- Improved Base Stiffness
- Improved $\frac{\text{Static Mass}}{\text{Rotating Mass}}$ Ratio
- Reduced Vibration



Commercial vs. Industrial Fans

- Arrangement 3
- Concrete Bearing Pedestals
- Greater Bearing Support Stiffness
- Greater $\frac{\text{Static Mass}}{\text{Rotating Mass}}$ Ratio
- Lower Vibration



Commercial vs. Industrial Fans

- *Machined Bearing and Motor Mounting Surfaces*
- *Motor Soft Foot Reduction*
- *Prevention of Pinched Bearing*
- *Ease of Coupling Alignment*



Aerodynamics of Industrial Fans

- *Pressure & Flow Definitions*
- *Static Pressure Regain*
- *Density Calculation*
- *System Losses & System Curves*
- *Specific Speed*
- *Fan Laws*
- *Performance of Various Blade Shapes*

Pressure & Flow Definitions (AMCA 99)

- **Pressure:** Force per Unit Area
- **Absolute Pressure:** Value of pressure when the datum is absolute zero. Always Positive.
- **Barometric Pressure:** Absolute pressure exerted by the atmosphere at a location of measurement.
- **Gauge Pressure:** The differential pressure between a reference pressure, such as barometric pressure, and the absolute pressure at the point of measurement. It may be positive or negative.

Pressure & Flow Definitions (AMCA 99)

- **Static Pressure:** Exists by virtue of degree of compression only. If expressed as gauge pressure, may be +ve or -ve.
- **Velocity Pressure:** Exists by virtue of rate of motion only. Must be +ve only.
- **Total Pressure:** Algebraic sum of Static and Velocity pressure at a measurement point.

Pressure & Flow Definitions (AMCA 99)

- Fan Total Pressure (FTP): Difference in total pressure between the fan outlet and inlet.

$$FTP = TP_O - TP_I$$

- Fan Static Pressure(FSP): Static pressure at the outlet minus the total pressure at the inlet.

$$FSP = SP_O - TP_I$$

- Static Pressure Rise (SPR): Difference in static pressure between the fan outlet and inlet.

$$SPR = SP_O - SP_I$$

Pressure & Flow Definitions (AMCA 801)

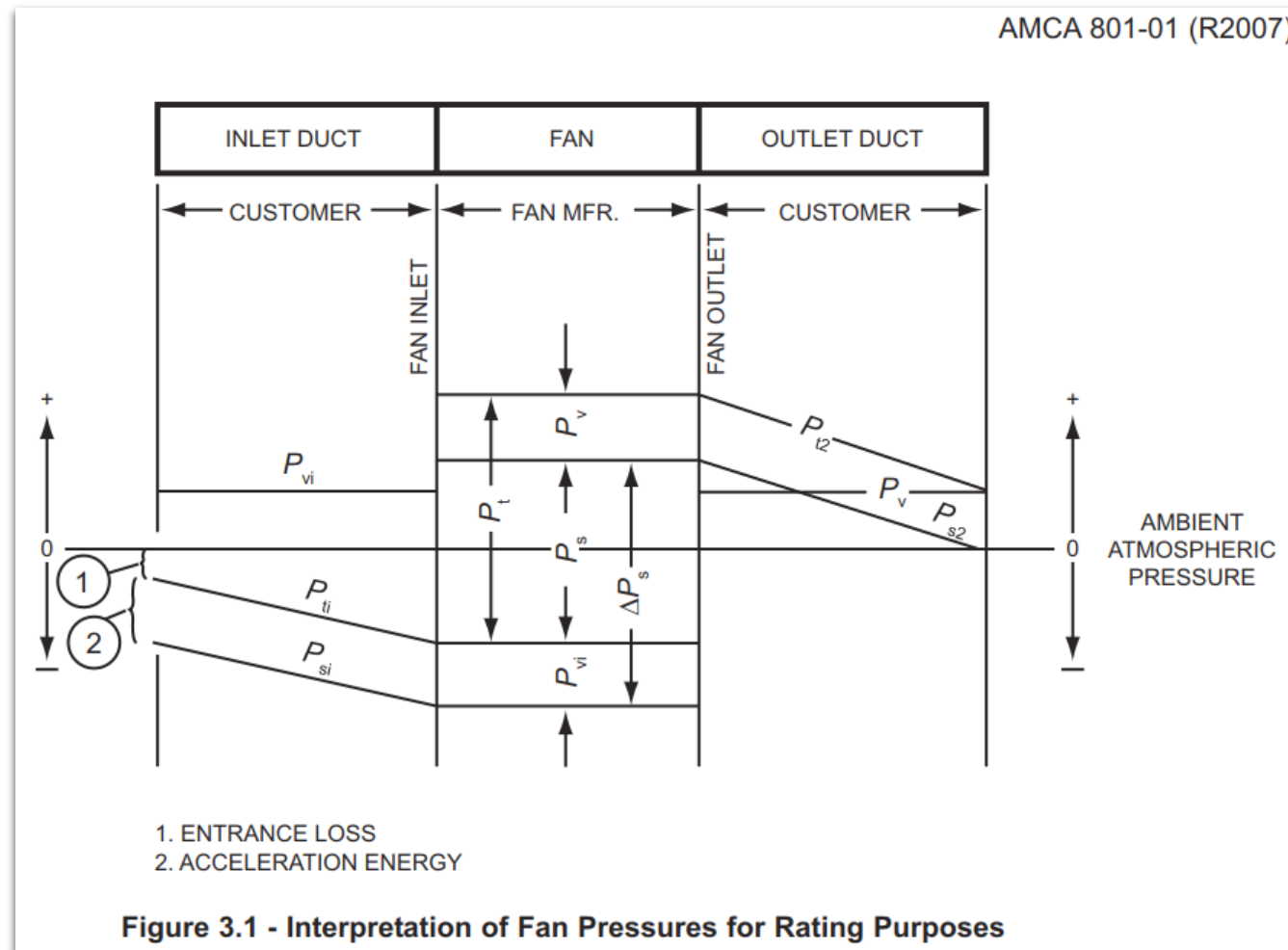

Static Pressure Regain

- *Most fans (in North America) are rated on SP at the fan outlet.*
- *Most fans have a higher outlet velocity than customers want flowing through the ductwork.*
- *By expanding the outlet duct, it is possible to convert velocity pressure to static pressure (Bernoulli).*
- *This allows for the fan to be smaller and the HP lower to produce the desired outlet SP.*

Pressure & Flow Definitions (AMCA 801)

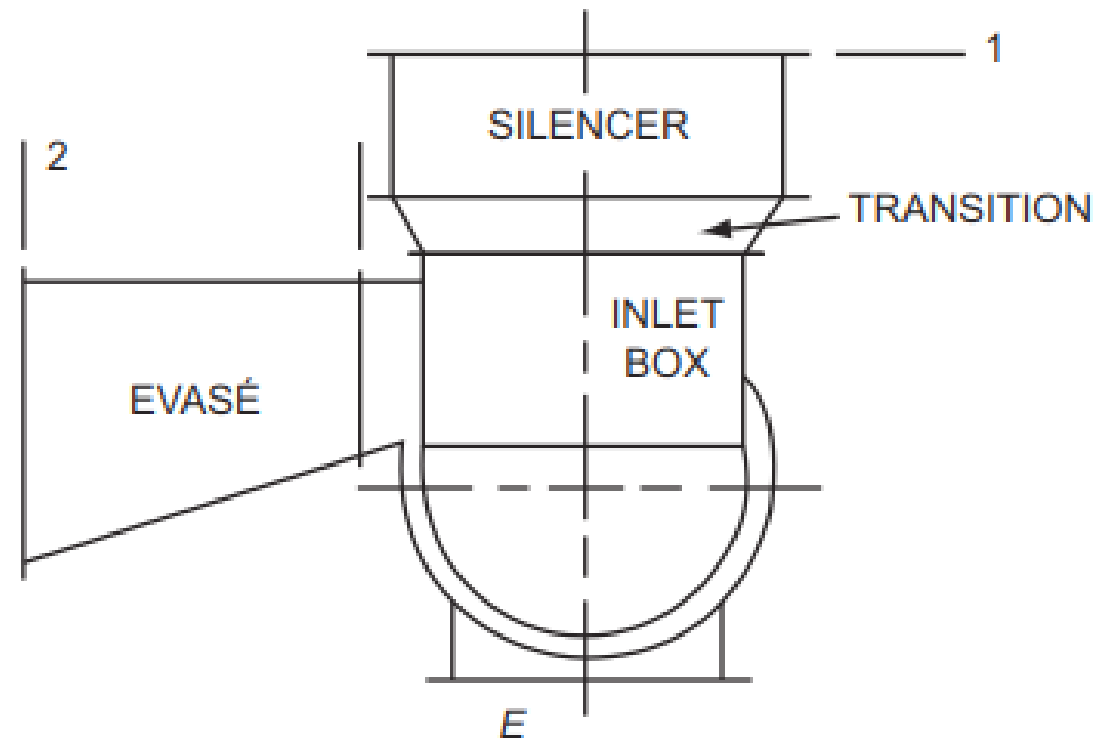

Pressure & Flow Definitions (AMCA 99)

- *Actual volume flow rate:* Actual volume flow rate through a plane of measurement; at the defined air density, expressed as $\text{ft}^3/\text{min}(\text{cfm})$ or m^3/s .
- *Standard Flow Rate:* The volume airflow rate through a plane of measurement, corrected to standard air density of $0.075 \text{ lbm}/\text{ft}^3$; referred to as SCFM.
- *NORMAL flow rate:* The volume airflow rate through a plane of measurement, corrected to an air density of $1.292 \text{ kg}/\text{m}^3$ referred to as Nm^3/s .
- *Mass flow rate:* The mass of air that passes through a given area in a unit of time. Expressed as lbm/h or kg/s .

ALL Flow rates are expressed at the ***INLET*** of a Fan.

Density Calculation

- $Density (p) = 0.075 \times \frac{529.7}{(T+459.7)} \times \frac{P}{29.92} \times \frac{MW}{29.984} \quad (I-P)$
- $Density (p) = 1.2 \times \frac{293.15}{(T+273.15)} \times \frac{P}{101.3} \times \frac{MW}{29.984} \quad (SI)$

T: The temperature at the measurement location, °C or °F.

P: The absolute pressure at the measurement location, in Hg or kPa.

MW: The molecular weight of the gas.

Density Calculation

- Molecular Weight(MW) of DRY Air is **28.964**
- MW of Water (H₂O) is ~18
- So, moist air is less dense than dry air
- Standard Air is defined as air having these properties, approximately:

*Density of **1.2 kg/m³ (0.075 lbm/ft³)**, a specific heat ratio of 1.4, a viscosity of $1.819 \times 10^{-5} \text{ Pa}\cdot\text{s}$ ($1.222 \times 10^{-5} \text{ lbm/ft}\cdot\text{s}$) and an absolute pressure of 101.325 kPa (406.78 in. wg). Air at 20°C (68°F), 50% relative humidity, and 101.325 kPa (29.92 in. Hg).*

- **NORMAL** Air is defined at 0°C and SL and has a density **1.292 kg/m³**

Density Calculation

- *Why is Density so important?*
- *Recall that a fan is a constant volume device. Most applications that use fans are based on mass flow. Combustion air for burners, cooling air for coils, any petrochemical process. They all depend on a certain mass flow for proper operation.*

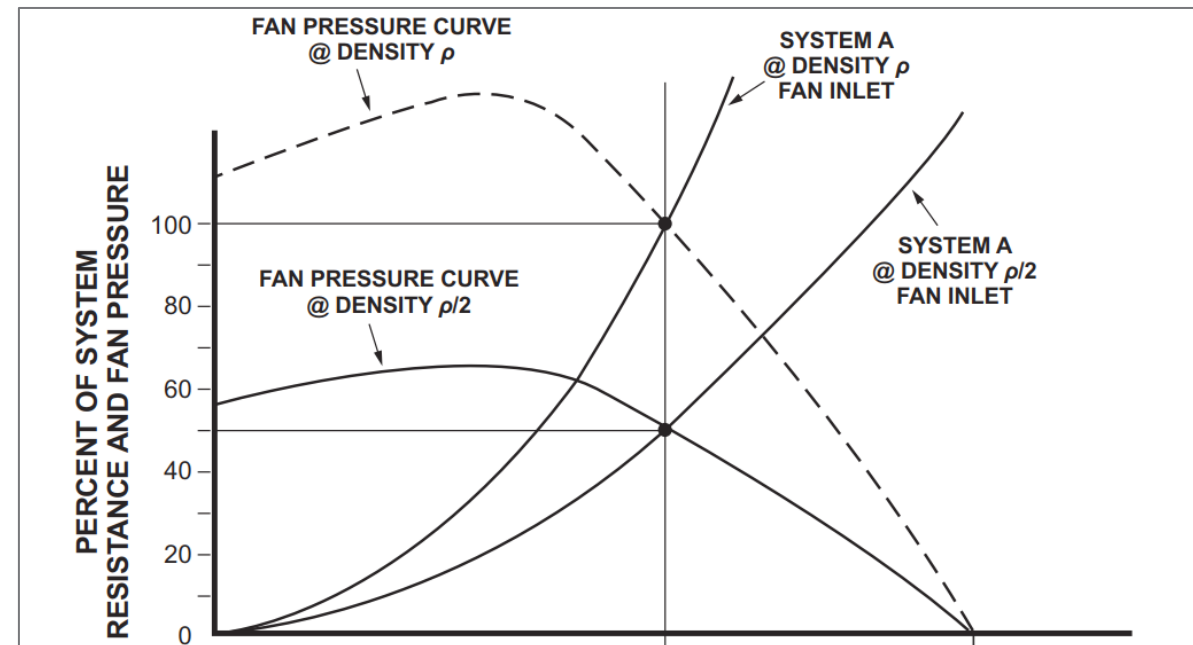

Density Calculation

Effect of Density on required flow rate

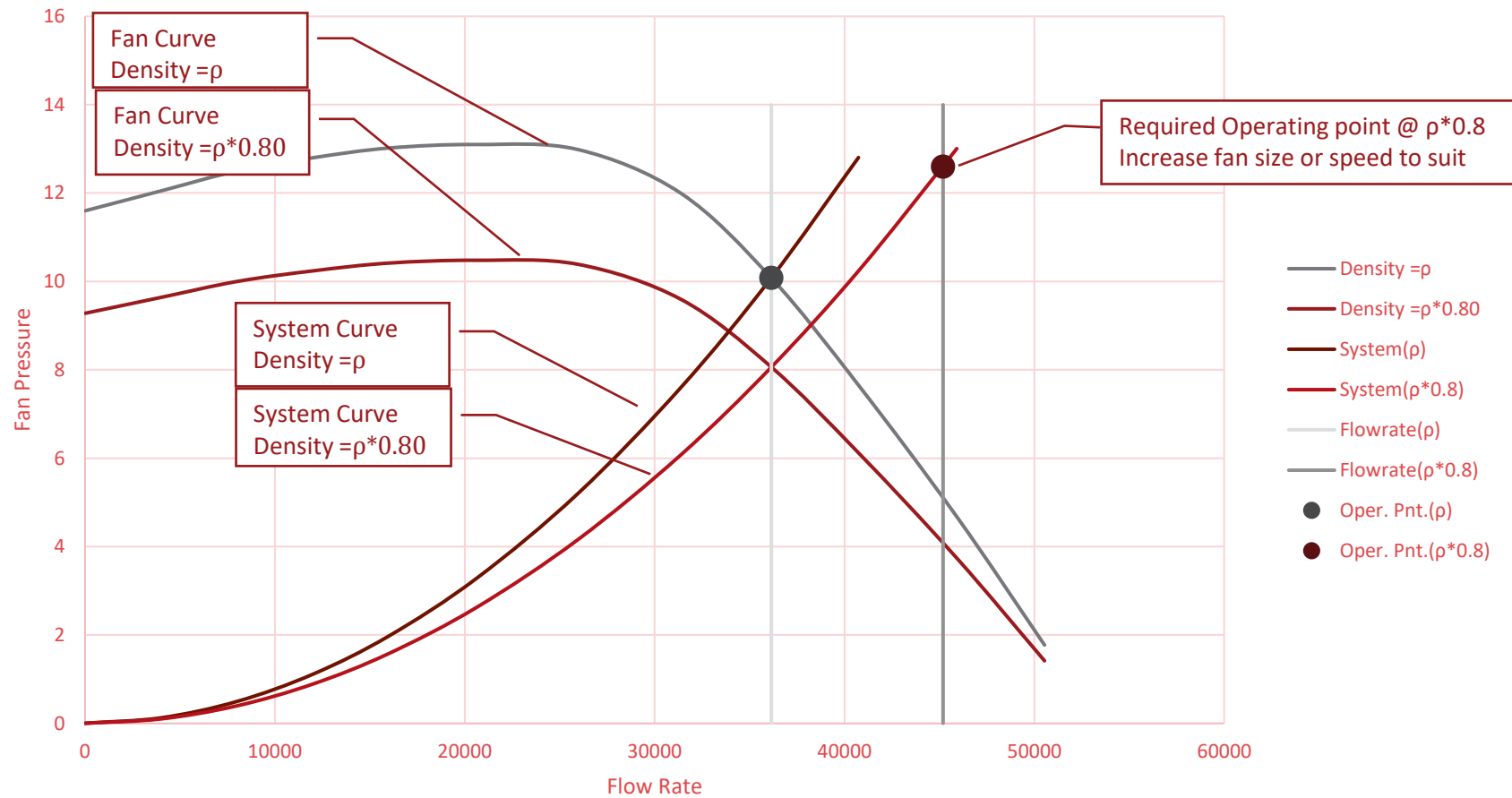

System Losses & System Curves

- *Flow in systems is created by a pressure difference between 2 points.*
- *System losses come from friction and turbulence.*
- *Bernoulli's principle: SP + VP at point 1 in a system is equal to SP + VP at point 2 plus friction + dynamic losses.*
- *Most system elements have losses that vary as the square of the flowrate:*

$$P_2 = P_1 \times (CFM_2/CFM_1)^2$$

System Losses & System Curves

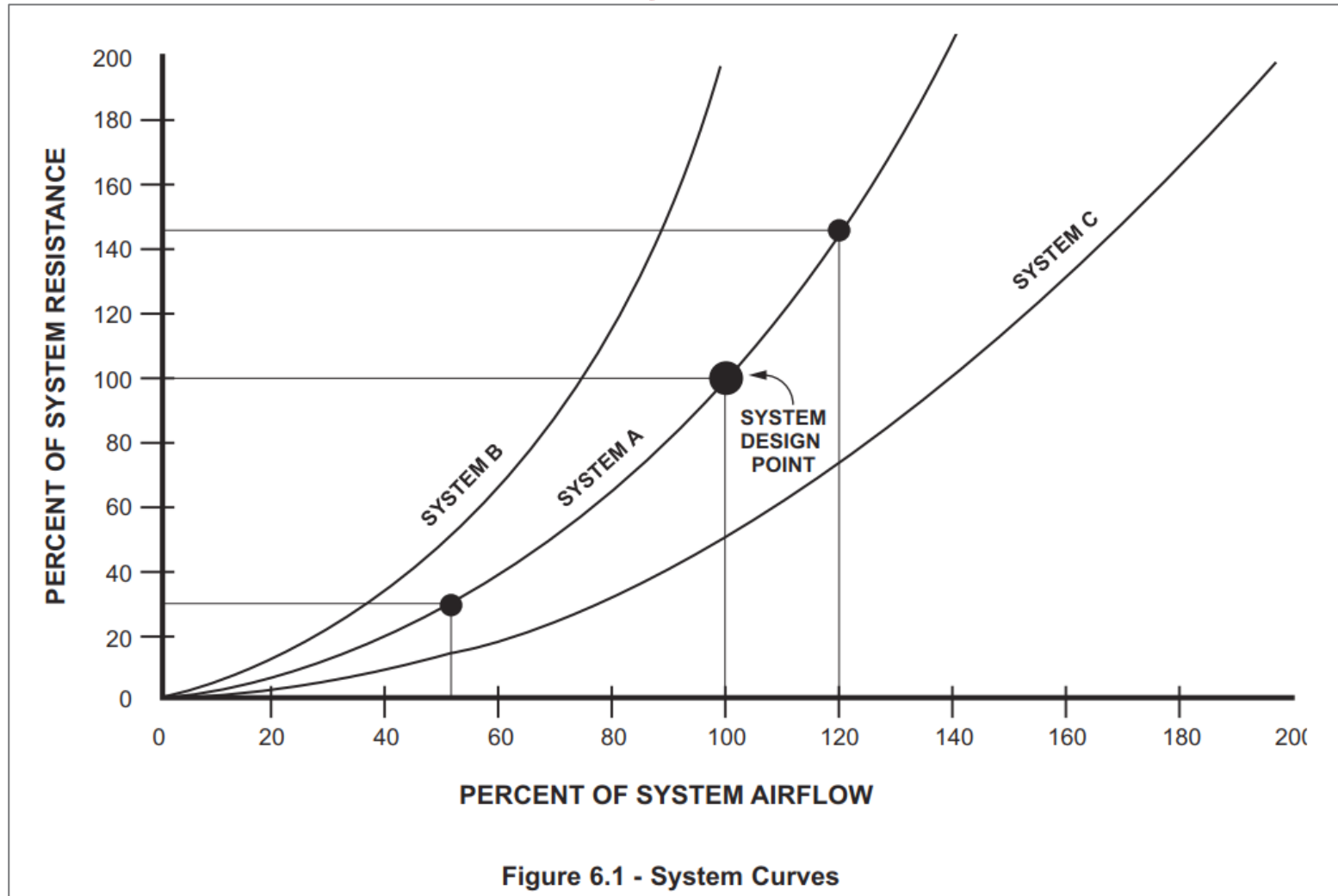

Interaction of System Curves and Fan Curve

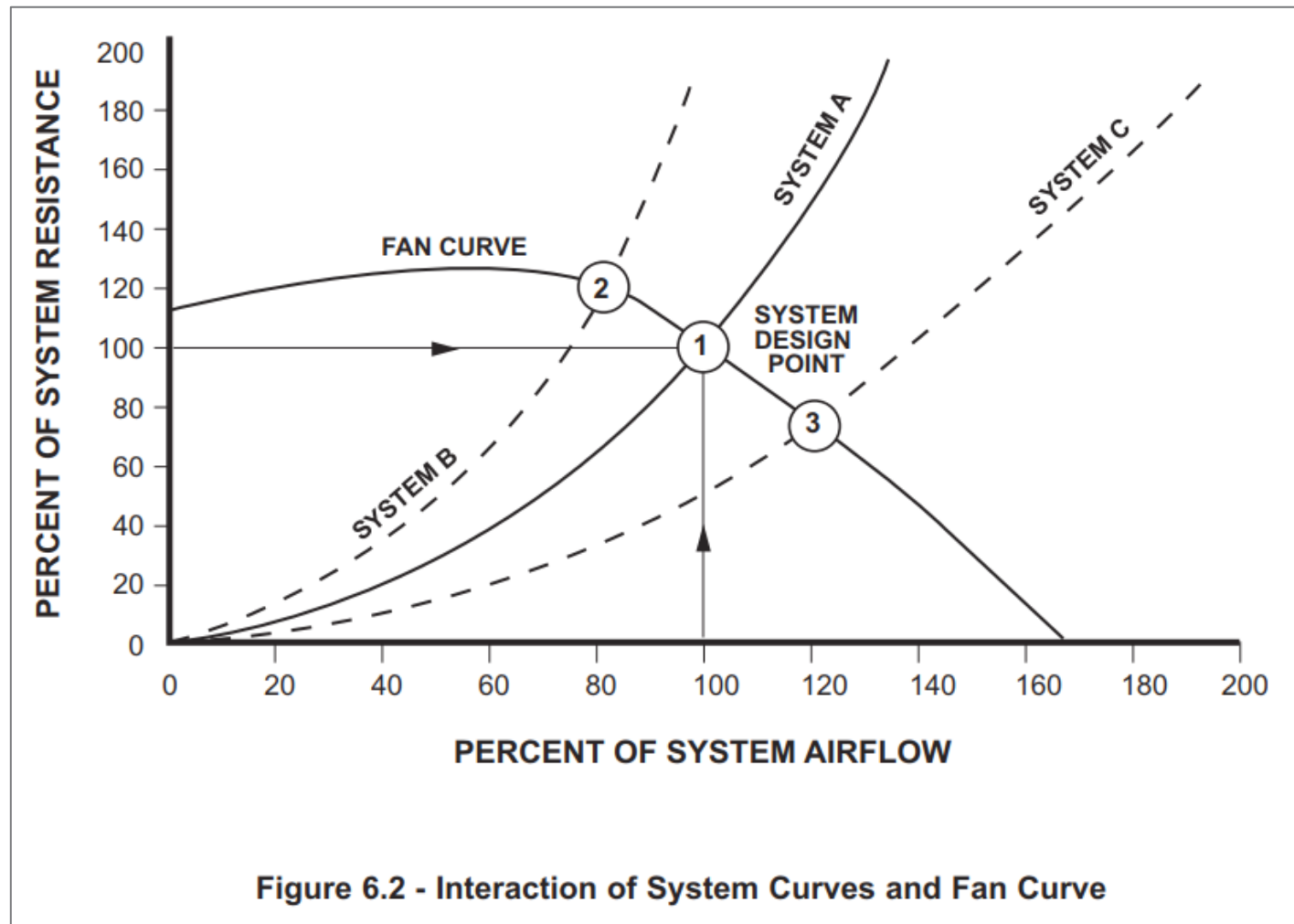

System Losses & System Curves

- *The continuity equation states that the flow at any 2 points in a system are equal ($Q_1 = Q_2$)*
- *Flow in systems is equal to the velocity times the cross-sectional area of the duct $Q = V \times A$*
- *So:*

$$V_1 \times A_1 = V_2 \times A_2$$

Specific Speed

- *Specific Speed*
 - *Dimensionless Value*

$$N_{SS} = \frac{N \times \sqrt{Q}}{SP_e^{0.75}}$$

N:= speed [rpm]
Q:= flow [cfm]
SP:= pressure [inWG]

- *Used to determine best fan for specified duty.*

Specific Speed

Efficiency vs. Specific Speed

$$N_{SS} = \frac{N \times \sqrt{Q}}{SP_e^{0.75}}$$

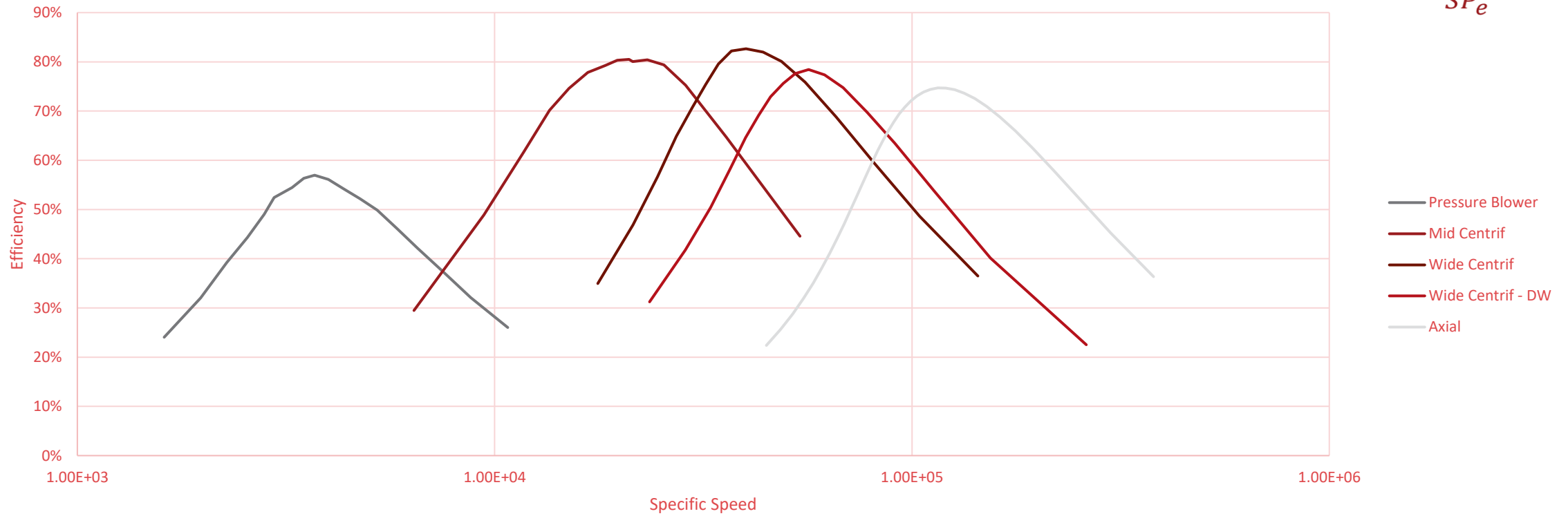

Fan Laws (Similarity Laws)

- *Laws of Geometric Similitude*
- *Allows prediction of performance of actual fans from model fan data.*

$$CFM_A = CFM_B \left(\frac{Dia_A}{Dia_B} \right)^3 \cdot \left(\frac{RPM_A}{RPM_B} \right)^1$$

A = Actual Size

B = Base Size

$$SP_A = SP_B \left(\frac{Dia_A}{Dia_B} \right)^3 \cdot \left(\frac{RPM_A}{RPM_B} \right)^2$$

$$HP_A = HP_B \left(\frac{Dia_A}{Dia_B} \right)^5 \cdot \left(\frac{RPM_A}{RPM_B} \right)^3$$

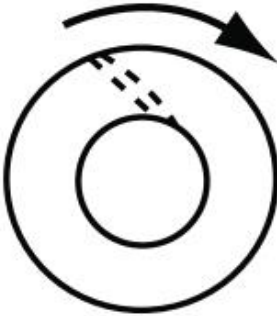
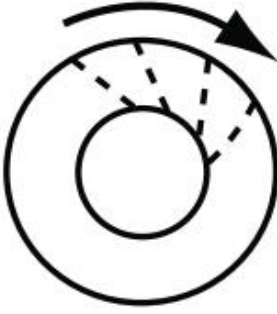

Impeller Designs (AMCA 201)

Centrifugal

AIRFOIL		<ul style="list-style-type: none">• Highest efficiency of all centrifugal fan designs.• Ten to 16 blades of airfoil contour curved away from direction of rotation. Deep blades allow for efficient expansion within blade passages• Air leaves impeller at velocity less than tip speed.• For given duty, has highest speed of centrifugal fan designs
BACKWARD- INCLINED BACKWARD- CURVED		<ul style="list-style-type: none">• Efficiency only slightly less than airfoil fan.• Ten to 16 single-thickness blades curved or inclined away from direction of rotation• Efficient for same reasons as airfoil fan.

Impeller Designs (AMCA 201)

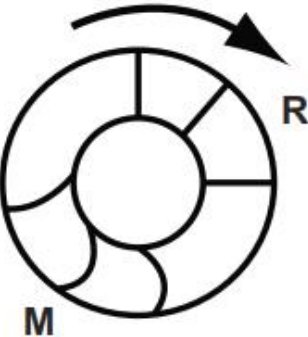
Centrifugal

RADIAL	 <ul style="list-style-type: none">• Higher pressure characteristics than airfoil, backward-curved, and backward-inclined fans.• Curve may have a break to left of peak pressure and fan should not be operated in this area.• Power rises continually to free delivery.
FORWARD-CURVED	 <ul style="list-style-type: none">• Flatter pressure curve and lower efficiency than the airfoil, backward-curved, and backward-inclined.• Do not rate fan in the pressure curve dip to the left of peak pressure.• Power rises continually toward free delivery. Motor selection must take this into account.

Impeller Designs (AMCA 201)

Axial

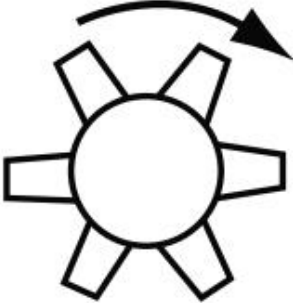
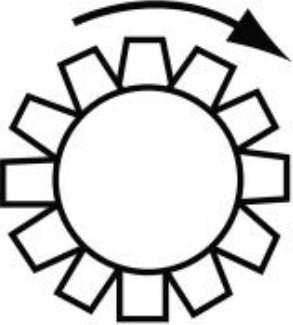
TUBEAXIAL		<ul style="list-style-type: none">• Somewhat more efficient and capable of developing more useful static pressure than propeller fan.• Usually has 4 to 8 blades with airfoil or single-thickness cross section.• Hub usually less than transfer by velocity pressure.
VANEAXIAL		<ul style="list-style-type: none">• Good blade design gives medium- to high-pressure capability at good efficiency.• Most efficient of these fans have airfoil blades.• Blades may have fixed, adjustable, or controllable pitch.• Hub is usually greater than half fan tip diameter.

Application of Industrial Fans

- *Segmentation based on environment:*
 - *Abrasive environment*
 - *Corrosive environment*
 - *High temperature applications*



REFERENCE: 2

Fans for abrasive environments



Application of Industrial Fans – Abrasive Environment

- Definition:

When particles in the airstream cause the wearing away of the fan surface by friction (typically blades and scroll housing).

- Typical applications:

- Centrifls – Cement, Iron and Steel, Dust collectors (dirty side), coal power plants
- Axials – Mining, coal power plants

Designing Against Wear

- Predict Where Wear will Occur
- Design those Areas to Minimize or Withstand Wear
 - Minimizing Wear
 - Use BC/BI Fans Instead of Radial - Half the Wear Rate
 - Use Wear Deflection Devices
 - Select Fans to operate at slower speeds
 - Withstanding Wear
 - Increase Component Thicknesses
 - Use Various Wear Protection Devices

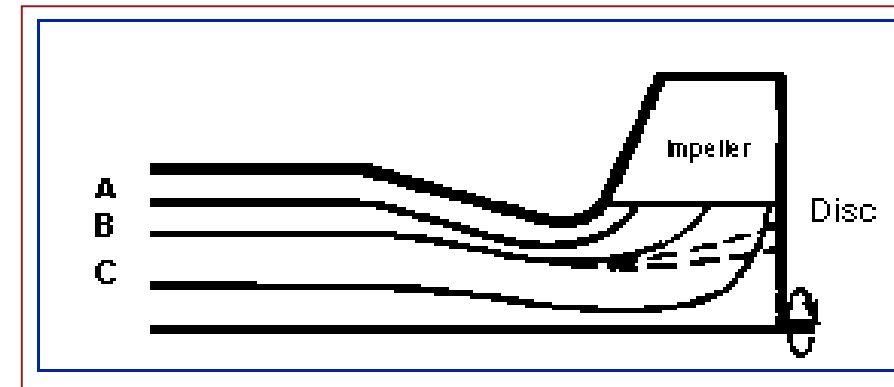

A – Small-sized particles
B – Medium-sized particles (~10 micron)
C – Large-sized particles (~100 micron)

Design Precautions – Abrasive Environment

- Design Precautions
 - Ensure accessories in the air stream (dampers, flex connectors, etc.) have wear protection.
- Axial Fans – typically the blades will be made from SG Iron (instead of aluminum). The leading edge of the blade or entire blade will have protection.

REFERENCE: 5

- Coating Options:
- High velocity oxygen fuel coating (mainly axials)

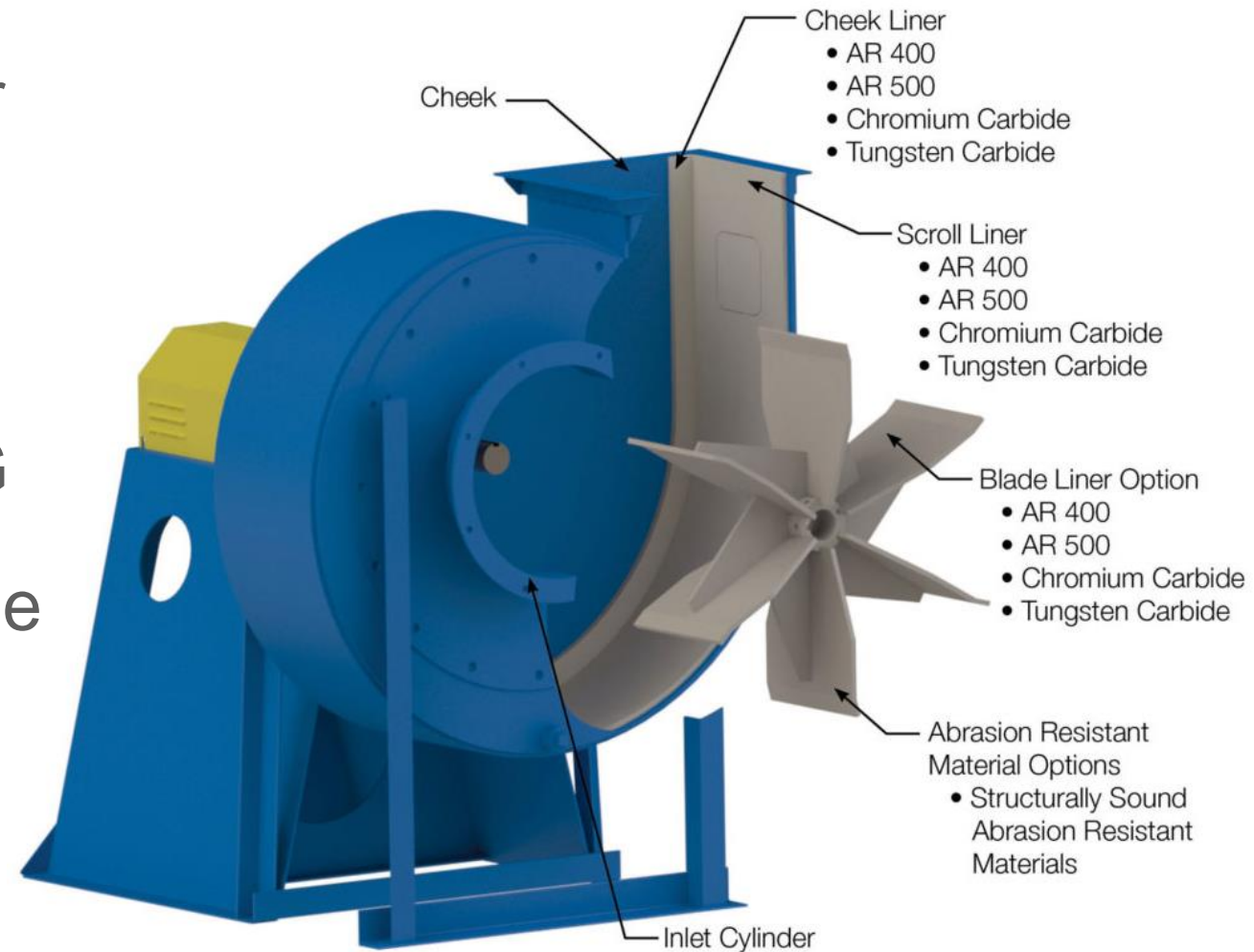

Material Selection – Abrasive Environment

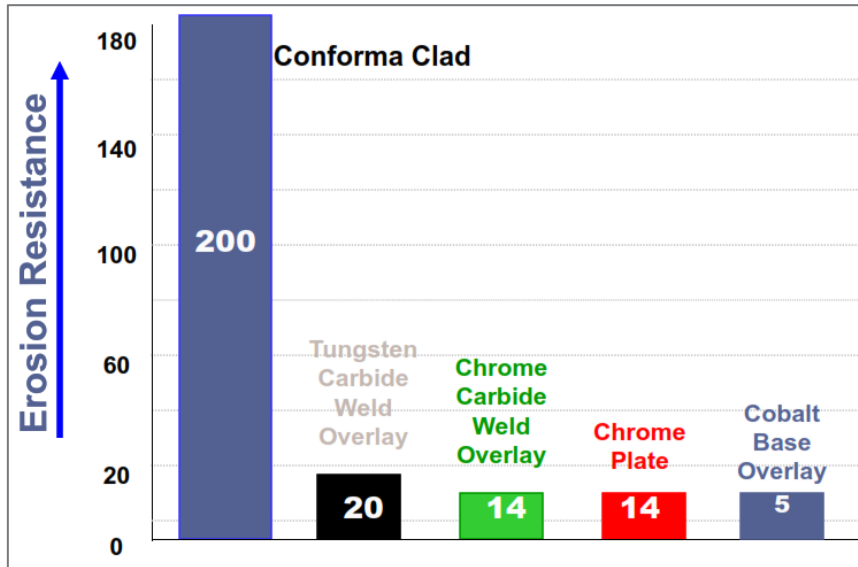

Wear Protection	Material Costs
Chrome Carbide Weld Overlay	X
Tungsten Carbide Weld Overlay	1.7 X
Conforma Clad	14 X

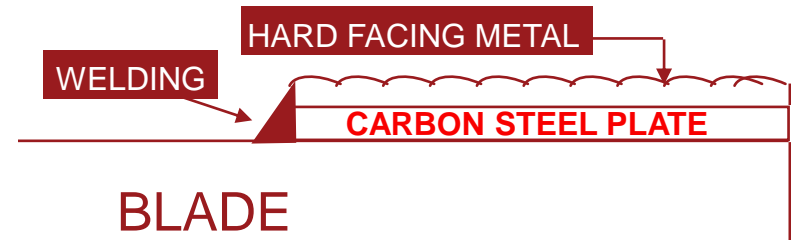

EPRI (Electric Power Research Institute) CS-6068, Project 1649-4 ASTM G73

Properties	WC Cladding	Thermal Spray	Weld Overlay	Plasma Spray	Tube Shields SS
Bond Strength	Very High	Very Low	High	Low	Low
Complex Geometries	Yes	No	Difficult	No	No
Abrasion Resistance	Very High	Moderate	High	Moderate	Low
Erosion Resistance	Very High	Low to Moderate	Low	Low	Low
Corrosion resistance	High	Low	Low	Low	High
Impact Resistance	Moderate	Low	Moderate	Low	Low
Oxide Level	Low	High	Low	High	High
Temperature Resistance	High	Moderate	Low	Moderate	High
Applied on Site	No	Yes	Yes	Yes	Yes
Resists Multiple Modes of Wear	Yes	No	Yes	No	No

- Hard facing material is never welded directly on the blades to avoid metallurgical problem.
- This protection can be easily replaced without modifying the mechanical structure of the impeller.



Design Considerations – Abrasive Environment

Decrease the speed

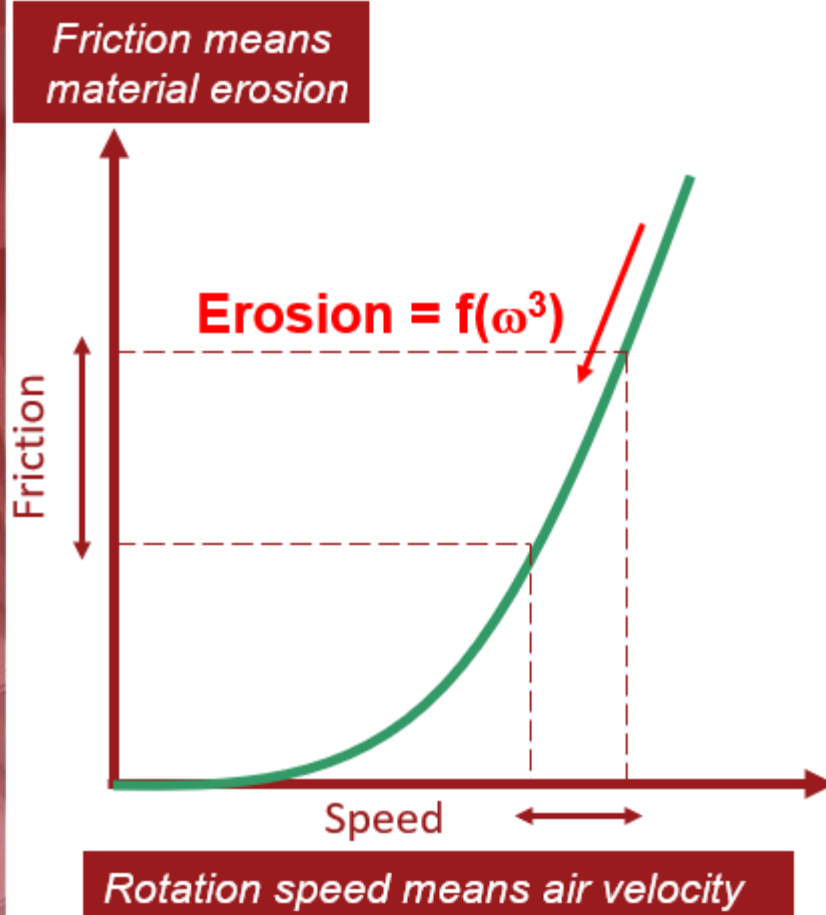

For the same air performance, having a bigger fan running slower than a smaller one **decreases** the material erosion. Air velocities vary with the rotational speed and erosion varies proportionally to the cube value of the air velocity. Reducing the rotation speed by half would result in **erosion divided by 8** (Erosion = $f(\omega^3)$)

Advantage:

Higher investment = larger fan = lower erosion = longer life



Design Considerations – Abrasive Environment Optimum Efficiency

Select the fan at its maximum efficiency in order to have smooth flow and prevent dead zones where the dusty build up can accumulate.

High efficiency fans are normally larger and hence more expensive. Some of these fans have machined components to ensure efficiency hence driving the costs up.

Advantage:

- High efficiency = lower power consumption = lower operating costs
- High efficiency = lower dead spots = less dust accumulation = reduced maintenance costs (unbalance)



Dust accumulates in dead air flow zone

Fans for corrosive environments

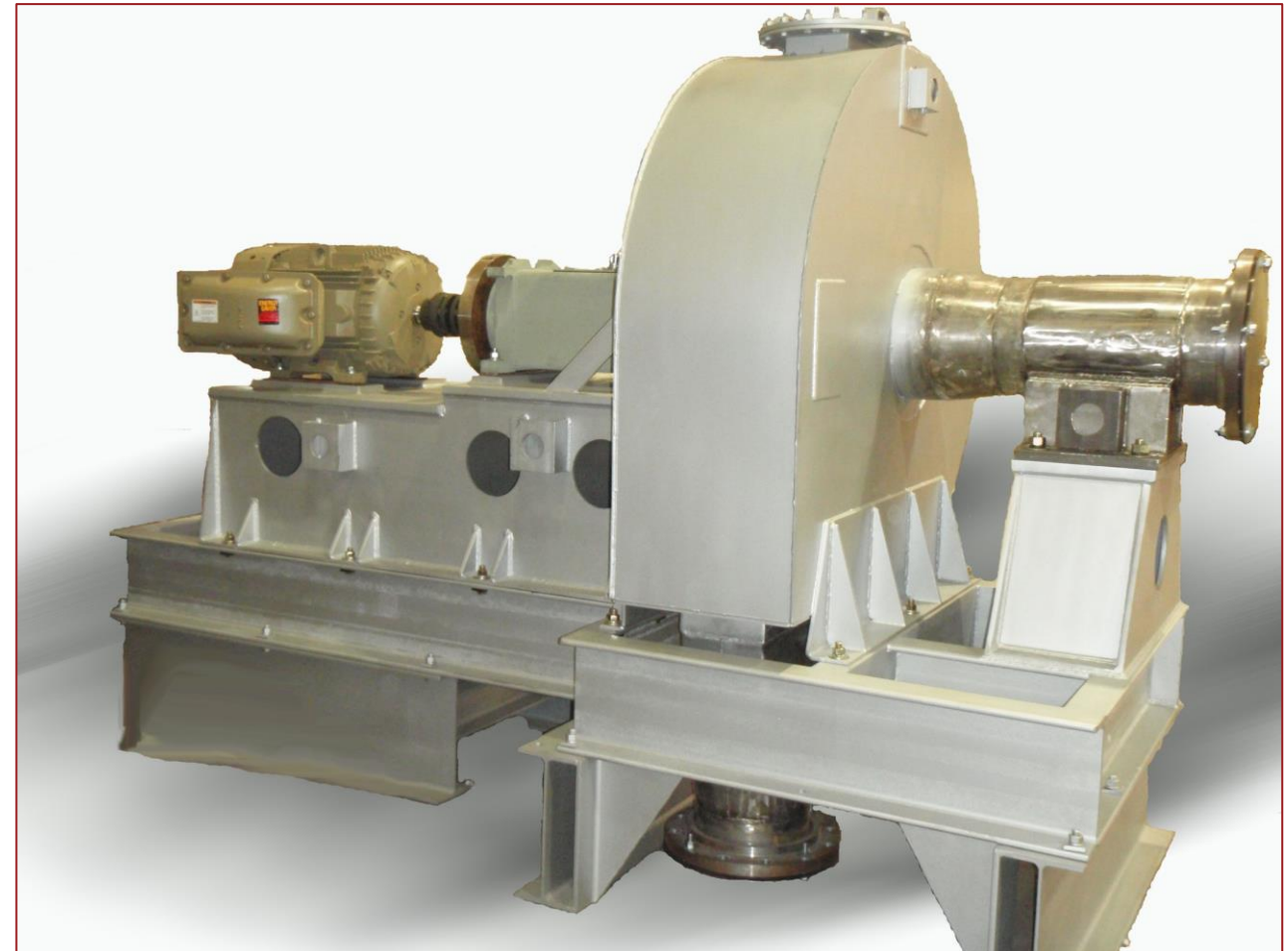

Application of Industrial Fans – Corrosive Environment

- Definition:

It is the gradual destruction of the material of construction of the fan due to a reaction with a chemical and/or electrochemical airstream.

- Typical applications:

- Centrifls and axials – Petrochemical plants, chemical processing, fertilizers, pharmaceutical, waste water treatment, laboratory ventilation, pulp and paper

REFERENCE: 8



~\$276 billion/yr.

The direct cost of corrosion in the U.S.A.

*www.corrosioncost.com

Design Precautions – Corrosive Environments

- Corrosive / flammable / hazardous air stream:
 - Air stream component construction (including accessories, hardware)
 - AMCA Anti Spark construction Standard 99
 - Low leak housing design (including accessories)
 - Shaft material selection
- Corrosive / flammable / hazardous (external) environment:
 - Fan external (outer housing, bases, etc.) construction (including accessories, hardware)
 - Motor/electrical specification
 - Bearing lubrication and protection
 - Shaft material selection

The Fan Manufacturer Must Rely on the Equipment User to Specify the Materials of Construction Appropriate for their Process.

Material Selection– Corrosive Environment

- Air stream material vs. Fan construction material

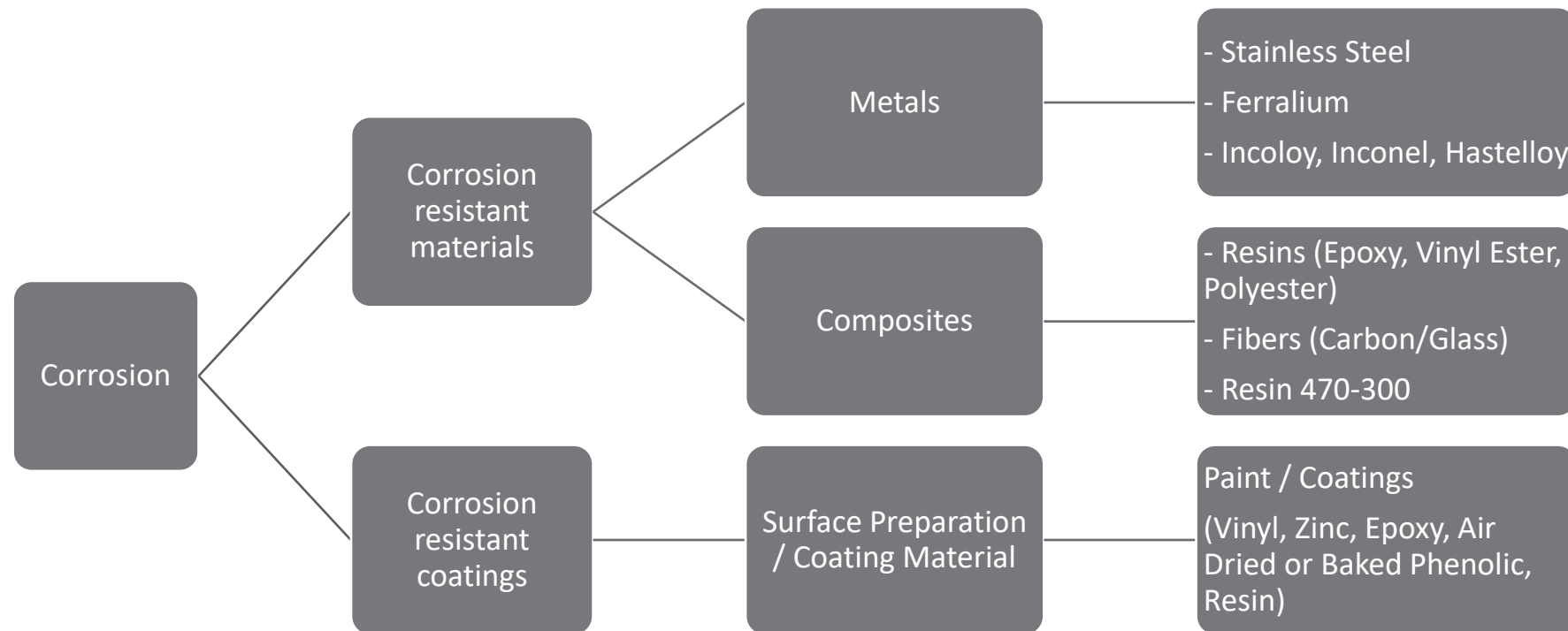

AMCA Standard 99-16 – Spark Resistance

Most Stringent



Least Stringent

Type	Construction
A	All parts of the fan or damper in contact with the air or gas being handled and subject to impact by particles in the airstream shall be made of nonferrous material. Ferrous shafts/axles and hardware exposed to the airstream shall be covered by nonferrous materials.
	Fans only: Steps must also be taken to assure that the impeller, bearings and shaft are adequately attached and/or restrained to prevent a lateral or axial shift in these components.
	Dampers only: Construction shall ensure that linkages, bearings and blades are adequately attached or restrained to prevent independent action. Ferrous containing bearings are acceptable if the bearings are located out of the airstream and shielded from particle impact.
B	Fans only: The fan shall have a nonferrous impeller and nonferrous ring about the opening through which the shaft passes. Ferrous hubs, shafts and hardware are allowed, provided construction is such that a shift of impeller or shaft will not permit two ferrous parts of the fan to rub or strike. Steps must also be taken to assure that the impeller, bearings and shaft are adequately attached and/or restrained to prevent a lateral or axial shift in these components.
	Dampers only: Construction shall ensure that linkages, bearings and blades are adequately attached or restrained to prevent independent action. Damper blades shall be nonferrous.
C	Fans only: The fan shall be so constructed that a shift of the impeller or shaft will not permit two ferrous parts of the fan to rub or strike.
	Dampers only: Construction shall ensure that linkages, bearings and blades are adequately attached or restrained to prevent independent action. Damper blades shall be nonferrous.

Design Precautions – Corrosive Environments

Fan handling nitric acid, without a mechanical seal, leading to the damage of the bearings.

- Air stream material (wheel, shaft, inside of housing) to be suitable for chemical.
- Use mechanical seal with body suitable for chemical.
- Use low leak housing (double side welds, thicker flanges and shorter pitch between bolts of mating parts of the housing).



Leakage through seal causing bearing damage



Labyrinth Seal with positive compressed air supply



Fans for high temperature applications

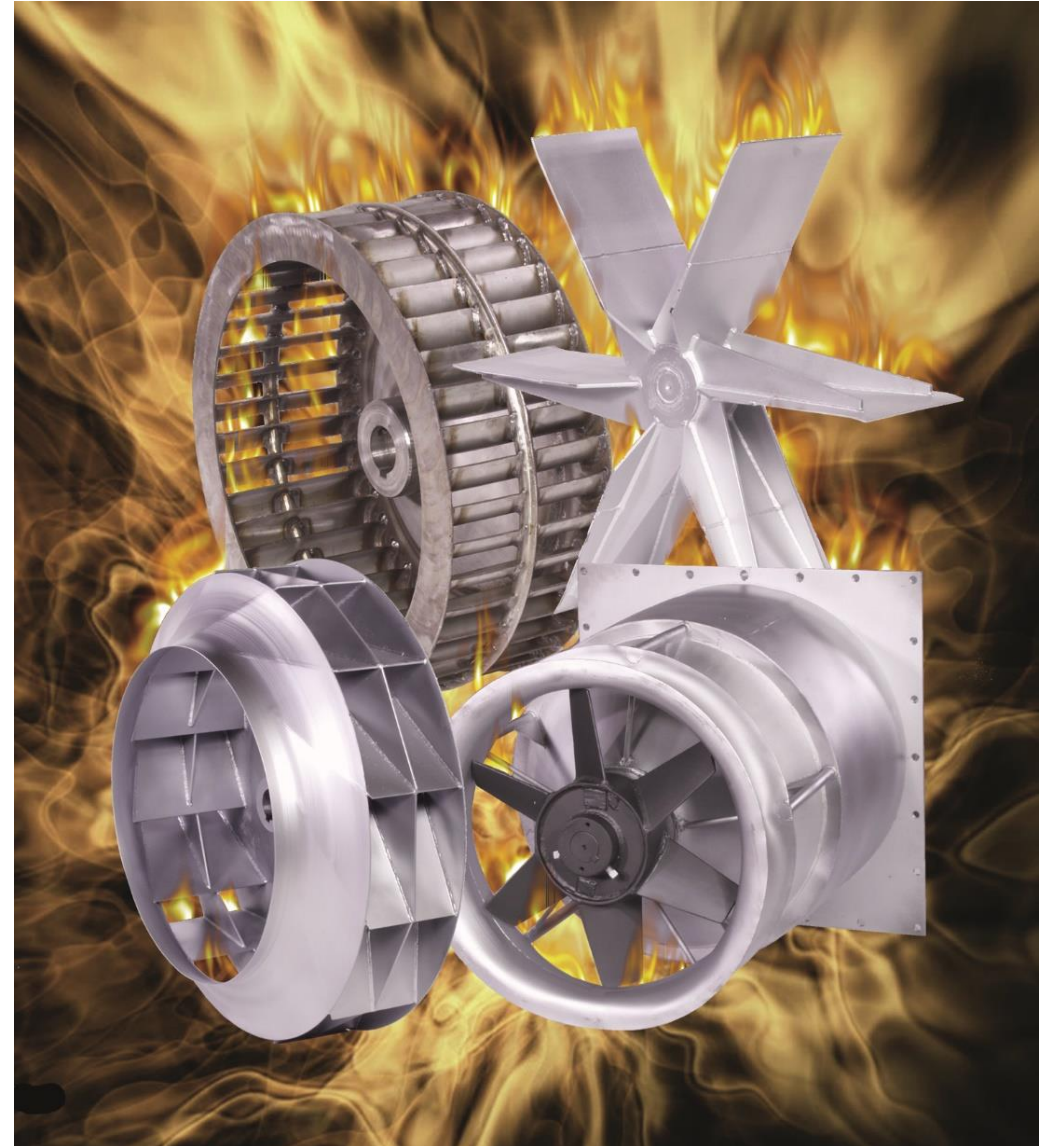

Application of Industrial Fans – High Temperature Environments

- **Definition:**

Fan manufacturers typically define an airstream temperature of 300 deg. F and above as high temperature.

- **Typical applications:**

- Centrifugals and axials – Petrochemical processing, forced circulation or recirculation of air or gas in furnaces, ovens, kilns and dryers (ID and FD fans).
- Several HVAC applications require high temp fans suitable for high temperatures for short durations (approx. 2 hrs.) as fire safety requirements, e.g.: tunnel ventilation, parking garage ventilation, commercial building ventilation.

Features of High Temp Fans

- Air stream materials to be suitable for temperature
- Housing to be insulated (safety and improve system efficiency)
- Typically a shaft seal is required to lower hot gases from escaping.
- Mechanism for the shaft and bearing to be cooled.
- Motor selection for hot start vs cold start.
- Axial fans – tip gap design.

REFERENCE: 4

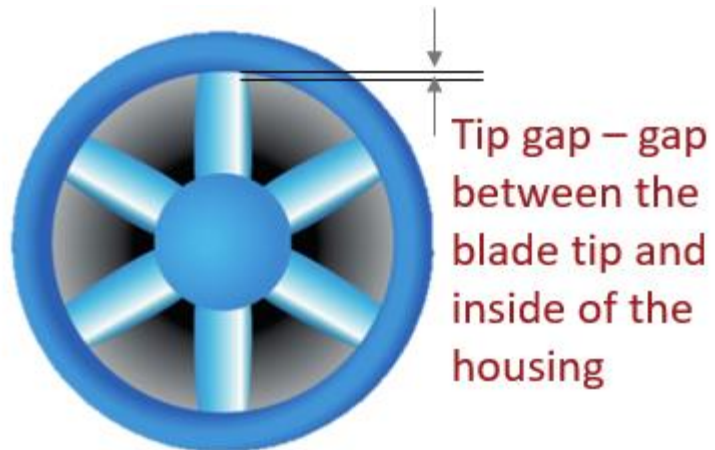

Temperature/ Atmosphere	Material	Material Costs
Up to 900 deg F	Carbon Steel	X
900 - 1550 deg F	Stainless Steel	3 X
1550-2000 deg F	Cobalt Laden Alloys	141 X
Corrosive	Hastelloy	80 X
Corrosive and high temperature	Inconel	46 X

Features of High Temp Fans



High Temp Style Pedestal with Standard Shaft Seal & Cooler



High Temp Style Pedestal With Shaft Cooler & Stuffing Box or Mechanical Shaft Seals

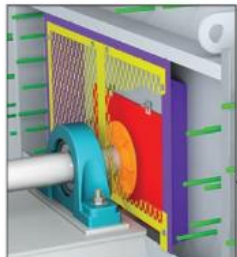

High Temp Style Pedestal with Cooler Box.

NOTE: Cooler Box provides uninsulated open area around the shaft cooler for dissipation of heat. Standard on fans with aluminum clad insulation & housing with insulation pins.

- Shaft Seal
- Shaft Cooler
- Insulation Pins (Optional)
- Safety Screen
- Cooler Box
- Raised Access Door (Optional)
- Insulation
- Extended Inlet Funnel
- Steel Wall Housing (Outer Shell)

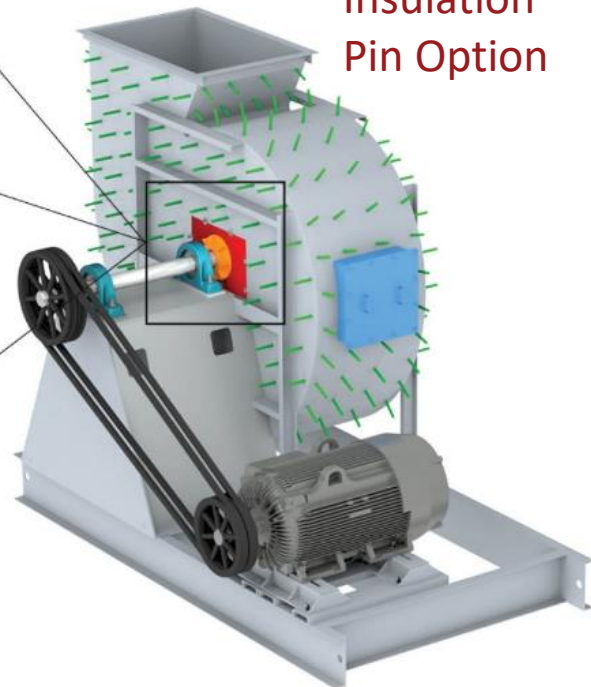

Insulation Pin Option

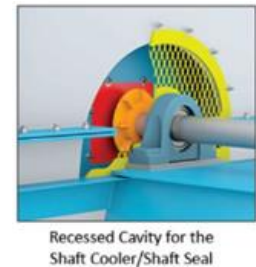
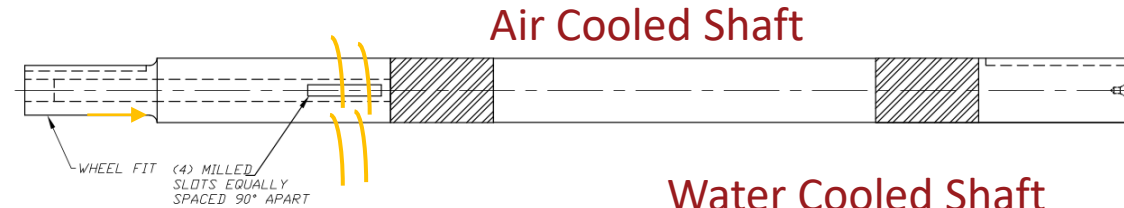

Recessed Cavity for the Shaft Cooler/Shaft Seal

Double Jacket Housing



"Green" Section is Added To Extend The Inlet Funnel

Water Cooled Shaft

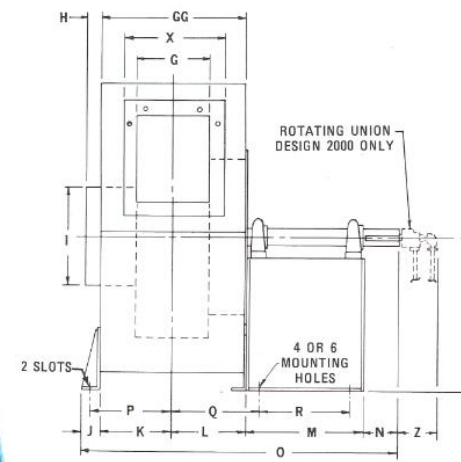

Features of High Temp Fans

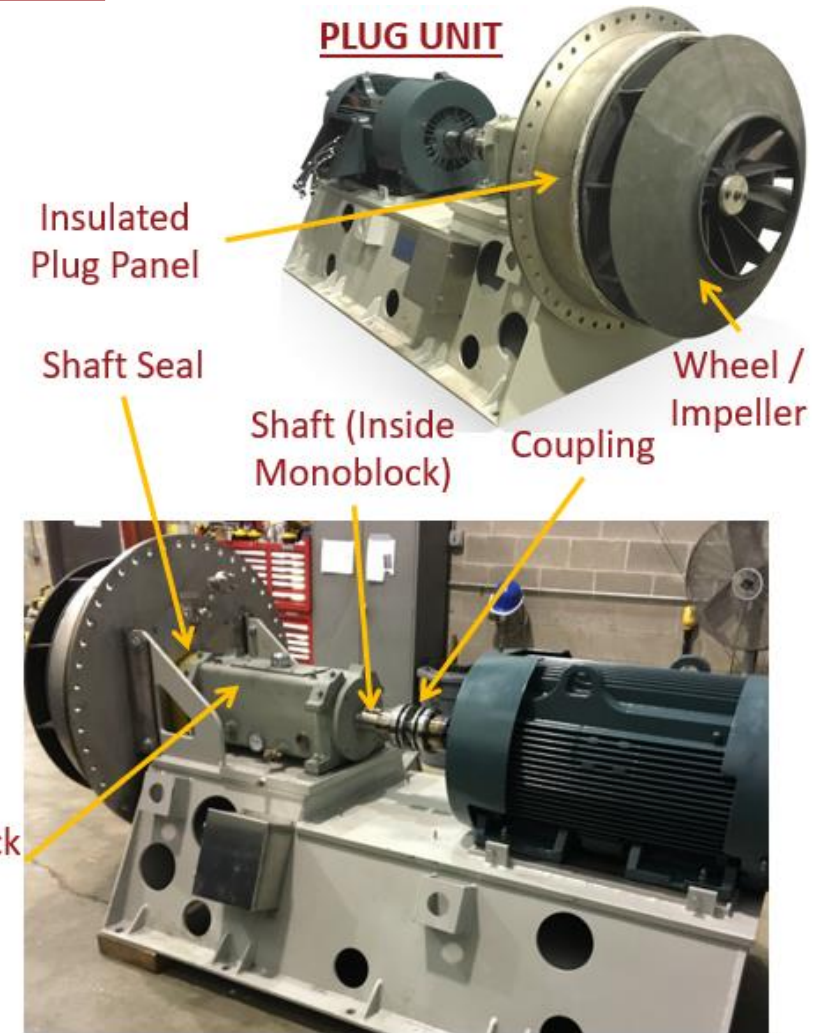
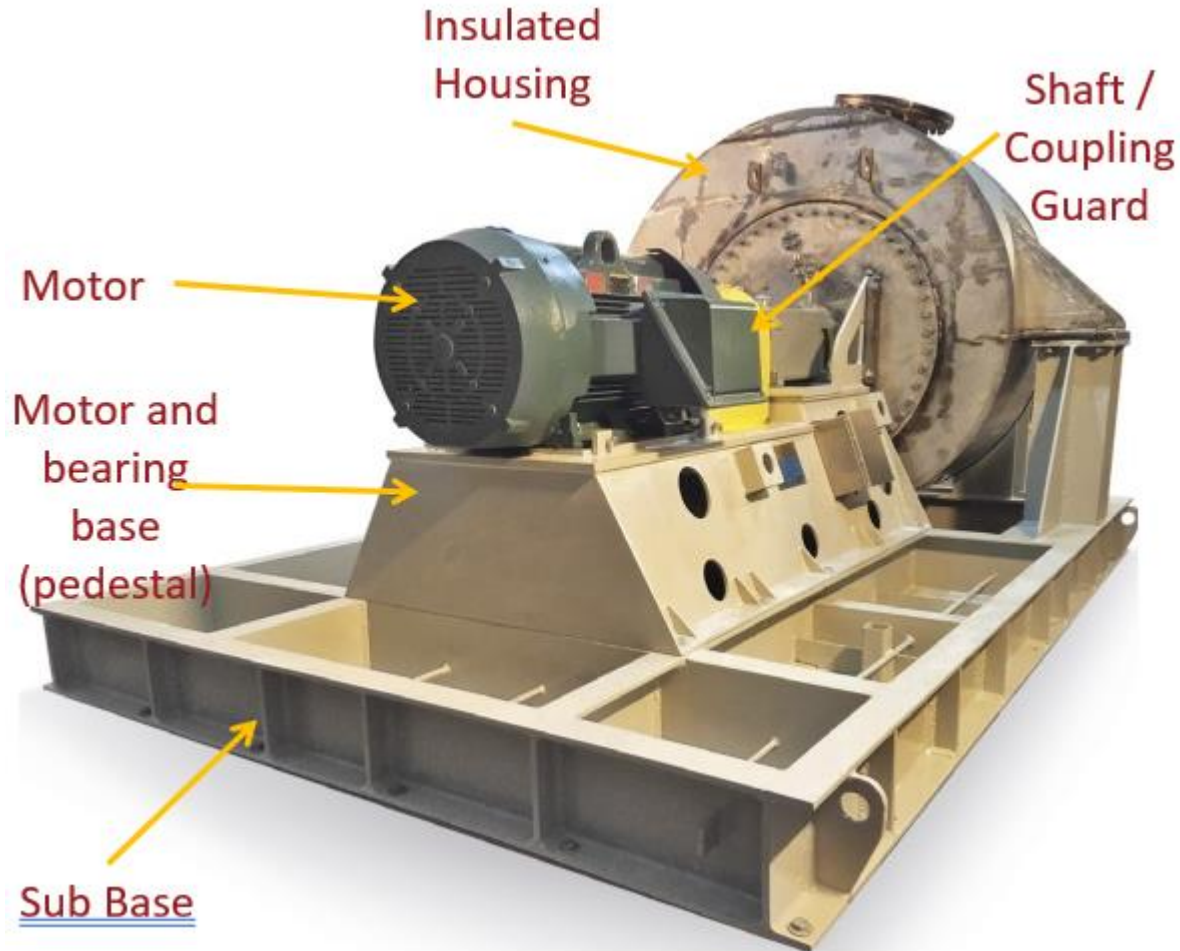

References

1. AMCA Standard 99
2. Howden - IQ C 09 DEV 2851 - Guidelines for the design of fans in cement process
3. Howden/Garden City Fan – Guidelines for corrosive applications
4. Howden/Garden City Fan – Guidelines for high temperature applications
5. Industrial Air Technology Corp. - Abrasion Resistant Fans
6. Kennametal – Technology Bulletin
7. Twin City Fan Company – FanPedia
8. www.corrosioncost.com

Resources

- **AMCA International:** www.amca.org
- **AMCA Publications:** www.amca.org/store (*Available for purchase*)
 - > **201-02 (R2011):** Fans and Systems
 - > **801-01 (R2008):** Industrial Process/Power Generation Fans: Specification Guidelines
- **ANSI/AMCA Standards:** www.amca.org/store (*Available for purchase*)
 - > **99-16:** Standards Handbook

Questions?

Thank you for your time!

To receive PDH credit for today's program, you must complete the electronic evaluation, which can be accessed at:

https://www.surveymonkey.com/r/AMCA_Rutgers_IAC_Webinar_May_20_2021

PDH credits and participation certificates will be issued electronically within 30 days, once all attendance records are checked and evaluations are received.

Attendees will receive an email at the address provided on your evaluation, listing the total credit hours awarded and a link to a printable certificate of completion.

***FOR MORE AMCA WEBINARS, GO TO:
www.amca.org/webinar***